

Watford

Sėdimų pagalvių sudedamosios dalys iš dviejų sluoksnių - porolonas+plunksnų pagalvė , atlošo pagalvėms taip pat naudojami plunksnos, aukšta komforto klasė

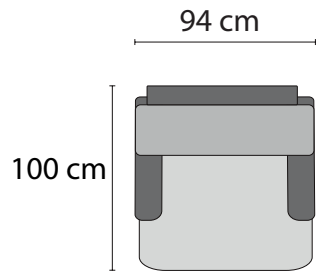

1so

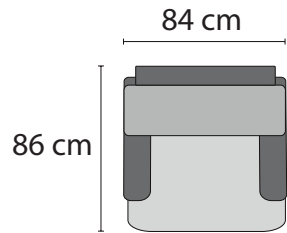

XS 1so

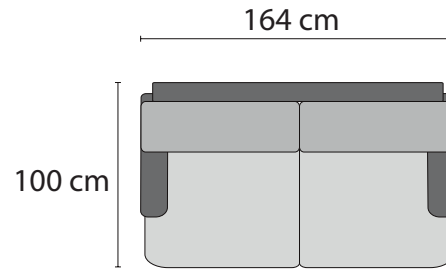

2so

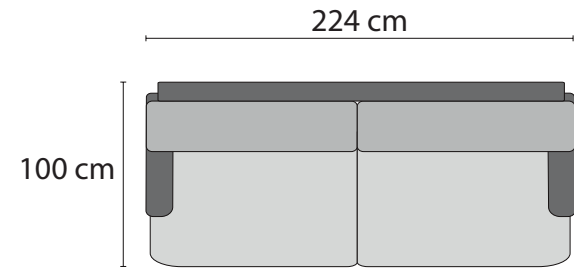

3so

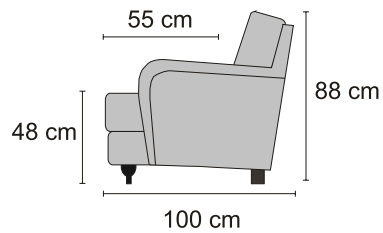

100 cm

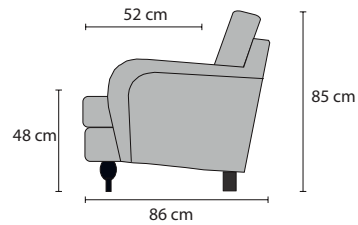

86 cm

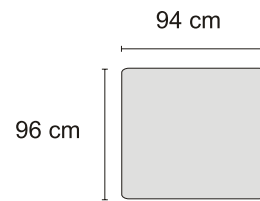

Banketė

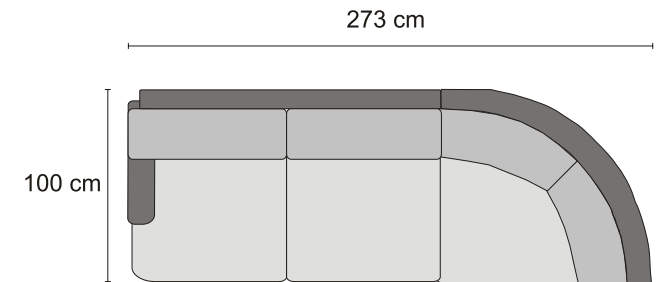

100 cm

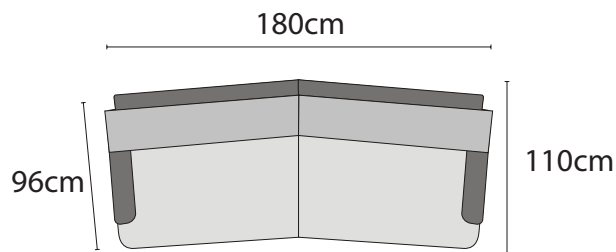

2 svang

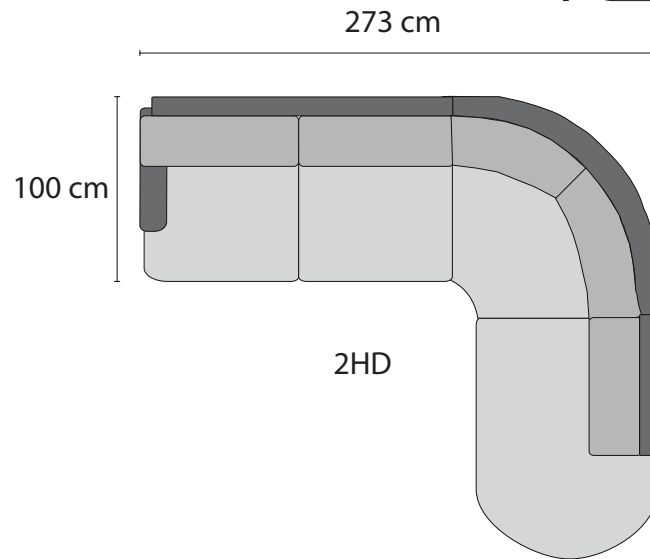

2HD

H22

240 cm

273 cm

100 cm

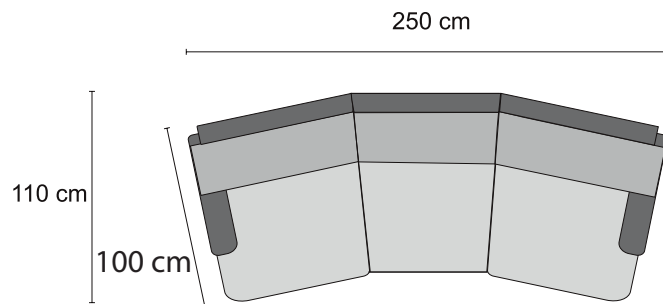

3 svang

100 cm